

Black and White Monitor

Model:

SSM-930

Operating Instructions Page 2

Before operating the unit, please read this manual thoroughly and retain it for future reference.

Mode d'emploi Page 11

Avant de mettre cet appareil en service, prière de lire attentivement ce mode d'emploi et de le conserver pour toute référence.



Owner's Record

The model and serial numbers are located at the rear.
Record the serial number in the space provided below.
Refer to these numbers whenever you call upon your Sony dealer regarding this product.

Model No. SSM-930 Serial No. _____

WARNING

To prevent fire or shock hazard, do not expose the unit to rain or moisture.

	CAUTION RISK OF ELECTRIC SHOCK DO NOT OPEN	
<p>CAUTION : TO REDUCE THE RISK OF ELECTRIC SHOCK, DO NOT REMOVE COVER (OR BACK). NO USER-SERVICEABLE PARTS INSIDE. REFER SERVICING TO QUALIFIED SERVICE PERSONNEL.</p>		

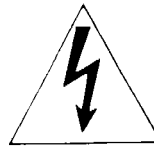

This symbol is intended to alert the user to the presence of uninsulated "dangerous voltage" within the product's enclosure that may be of sufficient magnitude to constitute a risk of electric shock to persons.



This symbol is intended to alert the user to the presence of important operating and maintenance (servicing) instructions in the literature accompanying the appliance.

CAUTION:

TO PREVENT ELECTRIC SHOCK, DO NOT USE THIS POLARIZED AC PLUG WITH AN EXTENSION CORD, RECEPTACLE OR OTHER OUTLET UNLESS THE BLADES CAN BE FULLY INSERTED TO PREVENT BLADE EXPOSURE.

For the customers in the U.S.A.

You are cautioned that any changes or modifications not expressly approved in this manual could void your authority to operate this equipment.

Table of Contents

Features	4
Precautions	5
Location and function of controls	6
Front panel	6
Rear panel	7
Connections	8
Connecting a video camera or a VCR	8
Connecting the monitors	9
Specifications	10

Features

- This unit can be used as a closed circuit television monitor or a video preview/playback monitor.
- Loop through connection allows up to three monitors to display the same picture.
- Electronic circuits provide safeguards against interference, noise and change of signal strength to maintain a clear and stable picture.
- This unit can be mounted in an EIA standard rack.

Precautions

Safety

- Operate the unit only on 120 V AC, 60 Hz.
- Should any liquid or solid object fall into the cabinet, unplug the unit and have it checked by a qualified personnel before operating it any further.
- Unplug the unit from the wall outlet if it is not going to be used for several days or more. To disconnect the cord, pull it out by the plug. Never pull the cord itself.
- Allow adequate air circulation to prevent internal heat build-up. Do not place the unit on surfaces (rugs, blankets, etc.) or near materials (curtains, draperies) that may block the ventilation holes.
- Height and vertical linearity controls located at the rear panel are for special adjustments by a qualified personnel only.

Installation

- Do not install the unit in an extremely hot or humid place or in a place subject to excessive dust or mechanical vibration.
- The unit is not designed to be waterproof. Exposure to rain or water may damage the unit.

Cleaning

Clean the unit with a slightly damp soft cloth. Use a mild household detergent. Never use strong solvents such as thinner or benzine as they might damage the finish of the unit.

If you have any question or problem concerning your unit that is not covered in this manual, please consult your nearest Sony dealer.

Location and Function of Controls

Front Panel

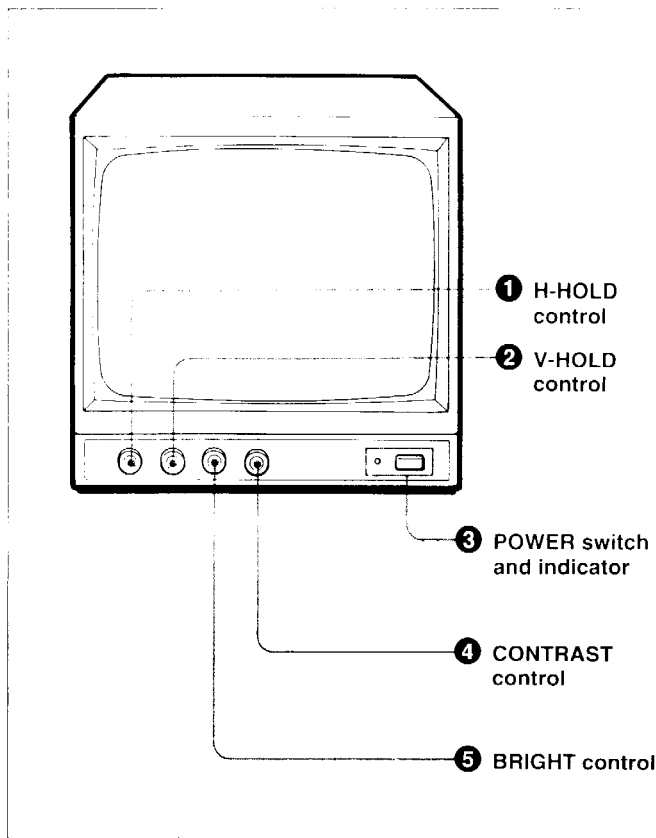

❶ H-HOLD (horizontal hold) control

When the picture has slanting horizontal bars, turn the H-HOLD control in either direction until a stationary picture is obtained.

❷ V-HOLD (vertical hold) control

When the picture rolls up or down on the screen, turn the V-HOLD control until a single stationary picture is obtained.

❸ POWER switch and indicator

To turn on the monitor, depress this switch. The green indicator lights up.

To turn off the monitor, press the switch again.

❹ CONTRAST control

Turn clockwise to increase picture contrast and counterclockwise to decrease it.

❺ BRIGHT (brightness) control

Turn clockwise for a brighter picture and counterclockwise for a darker picture.

Rear Panel

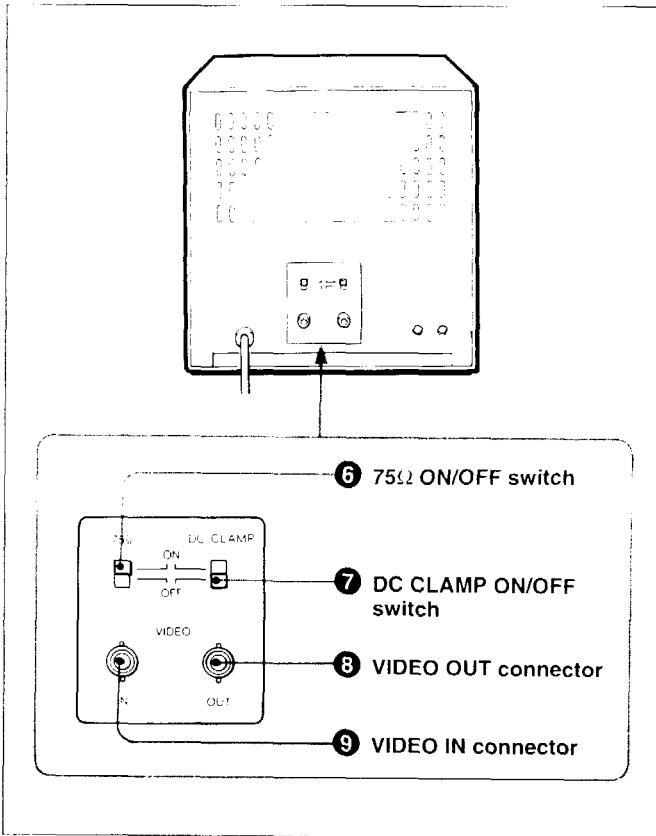

6 75Ω ON/OFF switch

Set to ON when you use only this monitor, or when you use this monitor as the last of the looped chain.

Set to OFF when you connect another monitor to the VIDEO OUT connector.

7 DC CLAMP ON/OFF switch

When the switch is set to OFF, the black and white part may become slightly gray.

To reproduce the black and white part faithfully, set to ON.

8 VIDEO OUT connector (BNC type)

Connect the video input of a VCR, or another monitor for loop-through connection.

9 VIDEO IN connector (BNC type)

Connect the video output of a VCR, video camera, or another monitor for loop-through connection.

Connections

Connecting a Video Camera or a VCR

Connect the VIDEO IN connector to the video output of a video camera or a VCR.

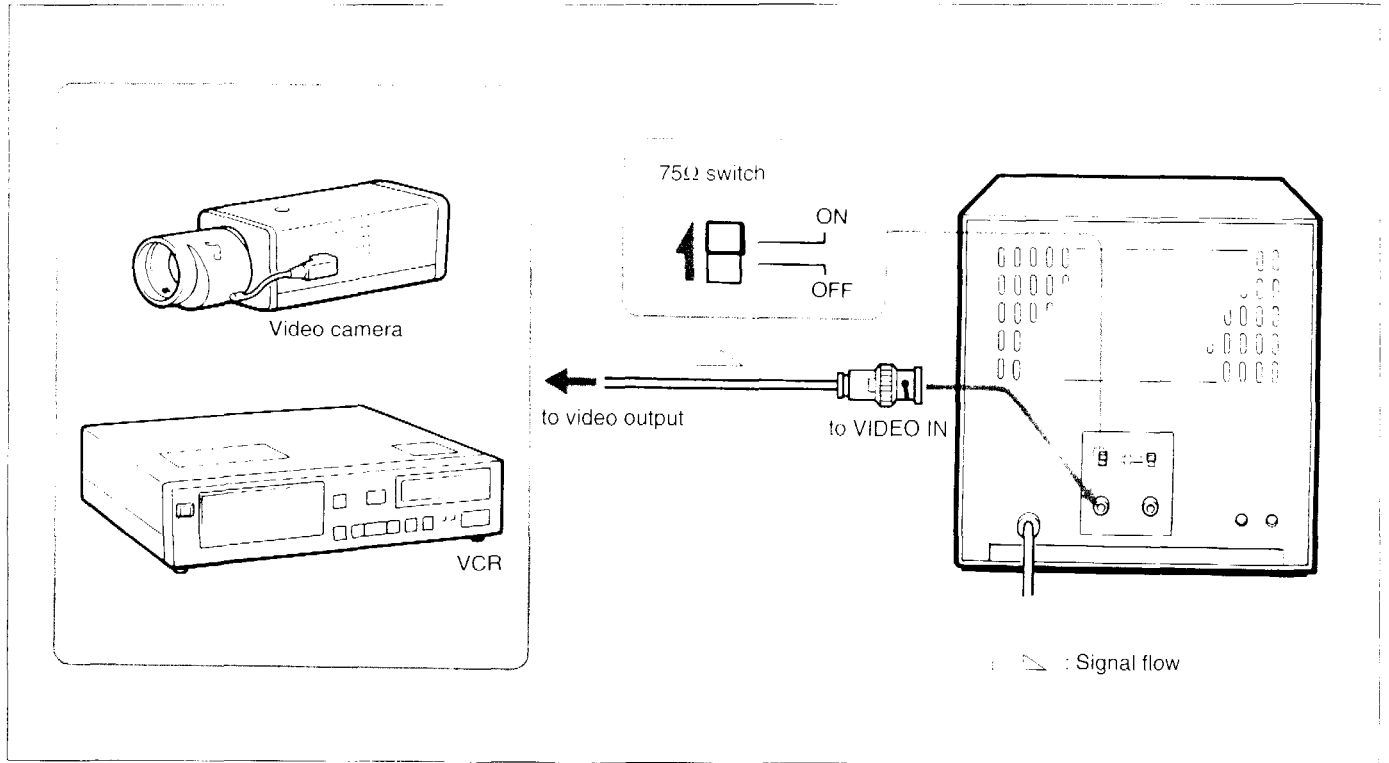

Connecting the Monitors

Using the loop-through feature of this unit, the same picture can be obtained on all the monitors connected. You can connect up to three monitors.

Adjust the picture contrast and brightness on each monitor.

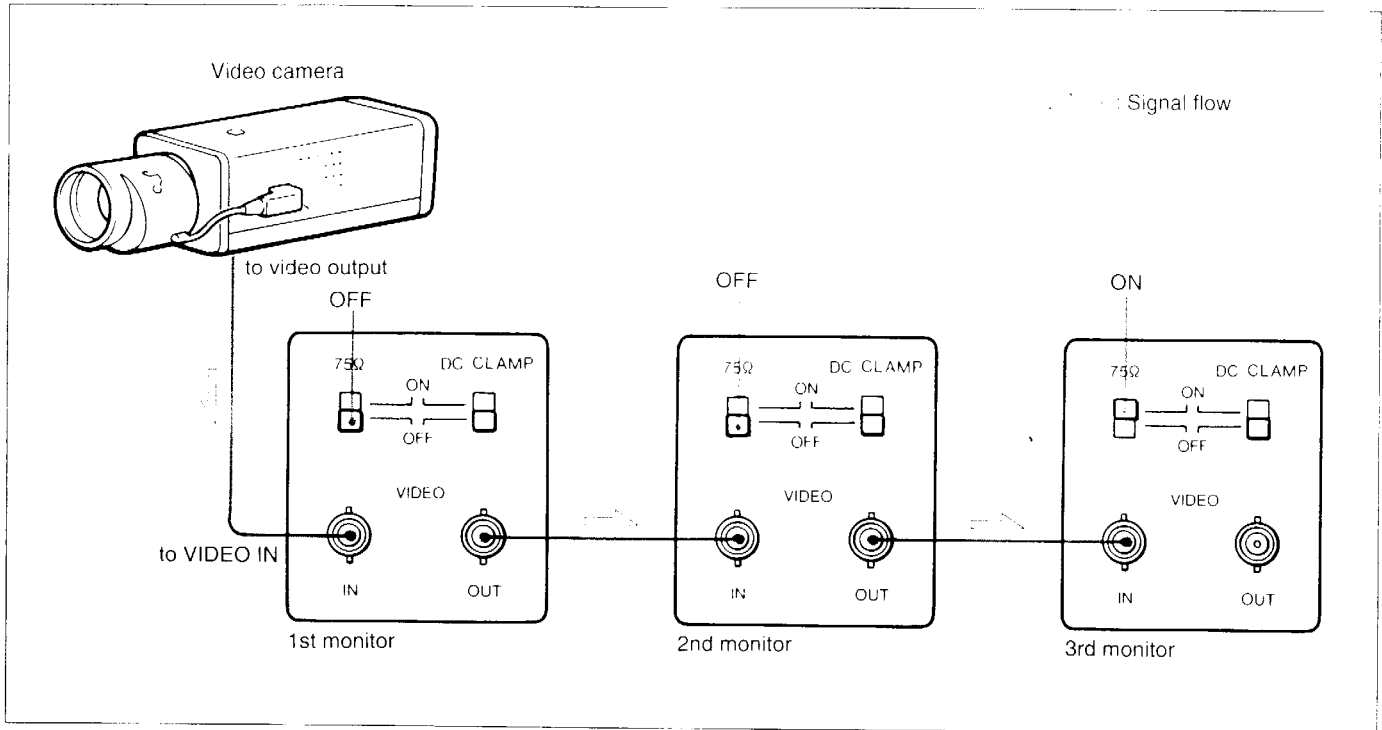

Specifications

System	EIA standard
Picture tube	9-inch picture measured diagonally 90-degree deflection
Resolution	More than 750 TV lines (horizontal)
Video input	Composite: 0.5—2 Vp-p. sync negative
Video input impedance	High impedance for loop-through; 75 Ω terminated
Video output	Composite: 0.5—2 Vp-p. sync negative
Video output impedance	Over 10 k Ω
Power requirements	120 V AC, 60 Hz
Power consumption	27 W
Dimensions	220 x 219 x 254 mm (w/h/d) (8 ³ / ₄ x 8 ⁵ / ₈ x 10 inches)
Weight	Approx. 5.8 kg (13 lb.)

Design and specifications are subject to change without notice.